



FLYABILITY
RANGE
EXTENDER
ORIGINAL
INSTRUCTIONS

VERSION 1.2
18.03.2021



EU DECLARATION OF CONFORMITY

We,

Flyability SA
EPFL INNOVATION PARK BLDG C, 1015 Lausanne, Switzerland
Tel: +41 21 311 55 00



declare under our sole responsibility that the products:

Range Extender (REx)

Range Extender (REx) Remote Control

to which this declaration relates is in conformity with the following standards or other normative documents:

Safety	EN 60950-1 – Range Extender (REx) Remote Control Information technology equipment. Safety. General requirements. Range Extender (REx) Risk assessment per EN ISO 12100:2010 – Safety of machinery. General principles for design. Risk assessment and risk reduction.
EMC	EN 300 328 V2.1.1 – Range Extender (REx) EN 300 328 V2.1.1 – Range Extender (REx) Remote Control Electromagnetic compatibility and Radio spectrum Matters (ERM): Wideband transmission systems; Data transmission equipment operating in the 2.4 GHz ISM band and using wide band modulation techniques; Harmonized EN covering the essential requirements of article 3.2 of the R&TTE Directive.
Radio	EN 300 440 V2.1.1 – Range Extender (REx) EN 300 440 V2.1.1 – Range Extender (REx) Remote Control Short Range Devices (SRD); Radio equipment to be used in the 1 GHz to 40 GHz frequency range; Harmonised Standard covering the essential requirements of article 3.2 of Directive 2014/53/EU. EN 303 413 V1.1.1 – Range Extender (REx) Remote Control Satellite Earth Stations and Systems (SES); Global Navigation Satellite System (GNSS) receivers; Radio equipment operating in the 1 164 MHz to 1 300 MHz and 1 559 MHz to 1 610 MHz frequency bands; Harmonised Standard covering the essential requirements of article 3.2 of Directive 2014/53/EU.
Health	EN 50663: 2017 – Range Extender (REx) EN 50663: 2017 – Range Extender (REx) Remote Control Generic standard for assessment of low power electronic and electrical equipment related to human exposure restrictions for electromagnetic fields (10 MHz - 300 GHz). EN62479: 2010 – Range Extender (REx) EN62479: 2010 – Range Extender (REx) Remote Control Assessment of the compliance of low power electronic and electrical equipment with the basic restrictions related to human exposure to electromagnetic fields (10 MHz to 300 GHz).

following the provisions of

- Machinery Directive (MD) 2006/42/EC, and
- Radio Equipment Directive (RED) 2014/53/EU

The Technical Construction File is maintained at:

Flyability SA
Avenue de Sévelin 20, 1004 Lausanne, Switzerland

The authorized representative located within the Community is:

Dr Adrien Briod
Chief Technology Officer
Avenue de Sévelin 20, 1004 Lausanne, Switzerland

A handwritten signature in black ink, appearing to read 'ABriod', positioned to the right of the contact information for Dr Adrien Briod.

Date: May 28th, 2018

FCC COMPLIANCE NOTICE

This equipment must be installed and operated in accordance with provided instructions and the antenna(s) used for this transmitter must be installed to provide a separation distance of at least 20 cm from all persons and must not be co-located or operating in conjunction with any other antenna or transmitter. End-users and installers must be provided with antenna installation instructions and transmitter operating conditions for satisfying RF exposure compliance.

This device complies with Part 15 of the FCC Rules. Operation is subject to the following two conditions:

1. This device may not cause harmful interference, and
2. This device must accept any interference received, including interference that may cause undesired operation.

Any changes or modifications not expressly approved by the party responsible for compliance could void the user's authority to operate the equipment.

This equipment has been tested and found to comply with the limits for a Class B digital device, pursuant to part 15 of the FCC Rules. These limits are designed to provide reasonable protection against harmful interference in a residential installation. This equipment generates, uses and can radiate radio frequency energy and, if not installed and used in accordance with the instructions, may cause harmful interference to radio communications. However, there is no guarantee that interference will not occur in a particular installation. If this equipment does cause harmful interference to radio or television reception, which can be determined by turning the equipment off and on, the user is encouraged to try to correct the interference by one or more of the following measures:

- Reorient or relocate the receiving antenna.
- Increase the separation between the equipment and receiver.
- Connect the equipment into an outlet on a circuit different from that to which the receiver is connected.
- Consult the dealer or an experienced radio/TV technician for help.

FCC RF EXPOSURE INFORMATION

Range Extender (REx)

This equipment complies with FCC radiation exposure limits set forth for an uncontrolled environment. In order to avoid the possibility of exceeding the FCC radio frequency exposure limits, human proximity to the antenna shall not be less than 20cm during normal operation.

FCC RF EXPOSURE INFORMATION

Range Extender (REx) Remote Control

SAR tests are conducted using standard operating positions accepted by the FCC/ISED with the device transmitting at its highest certified power level in all tested frequency bands, although the SAR is determined at the highest certified power level, the actual SAR level of the device while operating can be well below the maximum value. Before a new model is available for sale to the public, it must be tested and certified to the FCC/ISDEC that it does not exceed the exposure limit established by the FCC/ISDEC. Tests for each product are performed in positions and locations as required by the FCC/ISED.

For limb worn operation, this device has been tested and meets the FCC/ISED RF exposure guidelines when used with an accessory that contains no metal. For body worn operation, this device has been tested and meets the FCC/ISED RF exposure guidelines when used with an accessory designated for this product or when used with an accessory that contains no metal and that positions the device a minimum of 10 mm from the body. Non-compliance with the above restrictions may result in violation of RF exposure guidelines.

ISED RSS WARNING

This device complies with ISED licence-exempt RSS standard (s). Operation is subject to the following two conditions:

- (1) this device may not cause interference, and
- (2) this device must accept any interference, including interference that may cause undesired operation of the device.

Le présent appareil est conforme aux CNR d'Industrie Canada applicables aux appareils radio exempts de licence.

L'exploitation est autorisée aux deux conditions suivantes:

- (1) l'appareil ne doit pas produire de brouillage, et
- (2) l'utilisateur de l'appareil doit accepter tout brouillage radioélectrique subi, même si le brouillage est susceptible d'en compromettre le fonctionnement.

DISCLAIMER

Terms with initial capital letters shall have the following meanings:

- “Agreement” means the conditions of use of this Original Instructions and any other agreement between You and Flyability per which the Product has been delivered to You, including but not limited to Flyability’s General Terms and Conditions.
- “Flyability” means Flyability SA, a company incorporated in the Canton of Vaud in Switzerland under federal number CH-550.1156.670-6 (IDE CHE-348.376.646) having its registered offices at EPFL Innovation Park BLDG C, 1015 Lausanne, Switzerland
- “Product” means all goods and services described in this document.
- “You” means the person or legal entity to which the Product is delivered or who is operating the aircraft

All rights related to this document and all information it contained are the property of Flyability. REPRODUCTION, USE OR DISCLOSURE TO THIRD PARTIES WITHOUT PRIOR WRITTEN PERMISSION FROM FLYABILITY IS STRICTLY PROHIBITED.

By using the Products, software and systems of Flyability, You fully accept and consent, without reserve, Flyability’s warranty and liability terms stated below and all other terms and conditions agreed between You and Flyability.

1. Product limited warranty

By using the Product, You hereby signify that you have read, fully understood and agreed this disclaimer and the original instructions, and You agree that the Product:

- (i) May be unfitted to Your needs and purposes; and
- (ii) Should not be used under influence of alcohol, drugs or any substances that may impair cognitive abilities; and
- (iii) Is subject to local regulations that could prevent its use.

You shall pursue available remedies to You according to the Agreement. The warranty shall exclude defects due to misuse, non-observation of the Original Instructions, moisture or liquids, explosive gas, proximity or exposure to heat at temperatures exceeding the Operating temperature, excessive strain, abuse, neglect, misapplication, repairs or modifications made by anyone other than Flyability or certified by Flyability. There are no express or implied warranties, representations or conditions other than those stated in this limited warranty and the Agreement. The remedy set forth herein and in the Agreement shall be the sole, exclusive remedy with respect to the Product.

2. Product liability

IN NO EVENT OR UNDER ANY CIRCUMSTANCE, UNLESS EXPRESSLY STATED IN THE AGREEMENT, SHALL FLYABILITY SA, ITS DIRECTORS, OFFICERS OR EMPLOYEES BE LIABLE TO YOU OR TO ANY THIRD PERSON CLAIMING RIGHTS DERIVED FROM YOUR RIGHTS, IN CONTRACT, TORT OR OTHERWISE, FOR INDIRECT, SPECIAL, INCIDENTAL, EXEMPLARY, PUNITIVE OR CONSEQUENTIAL DAMAGES OF ANY KIND WHATSOEVER EVEN IF ADVISED OF THE POSSIBILITY OF SUCH

DAMAGES INCLUDING, BUT NOT LIMITED TO, ANY DAMAGES CAUSED BY YOU OR A THIRD PARTY WHILE OPERATING OR USING THE PRODUCT, ANY DAMAGES CAUSED BY FAILURE OF THE ELECTRONICS OR SOFTWARE, ANY LOSS OF REVENUE, LOSS OF PROFIT, OR LOSS OF DATA WHETHER BASED UPON ANY ALLEGED BREACH OF WARRANTY, REPRESENTATION OR CONDITION, CONTRACT, OR ANY OTHER CONDUCT INCLUDING NEGLIGENCE (INTENTIONAL OR OTHERWISE), GIVING RISE TO SUCH CLAIM. A Party who relies on a breach of the other Party's obligations under this Agreement, shall take any and all reasonable measures in the circumstances to mitigate the consequences, including loss of profit, resulting from the breach. If it fails to take such measures, the Party in breach may claim a reduction in the damages in the amount by which the consequences should have been mitigated.

YOU SHALL NOT OPERATE THE PRODUCT IN AREAS OR UNDER CIRCUMSTANCES WHERE A FAILURE COULD CAUSE DAMAGES AND/OR HARM TO OBJECTS AND/OR PEOPLE. YOU SHOULD HAVE READ AND UNDERSTOOD THE ORIGINAL INSTRUCTIONS COMPLETELY BEFORE OPERATING THE PRODUCT. ANY DAMAGE AND/OR HARM ARISING FROM NOT ACCURATELY FOLLOWING THE PROCESSES AND GUIDANCE FROM THE ORIGINAL INSTRUCTIONS SHALL BE THE SOLE RESPONSIBILITY OF THE OPERATOR OF THE PRODUCT.

ALL USE OF THE PRODUCTS IS UNDER YOUR SOLE RESPONSIBILITY, INCLUDING BUT NOT LIMITED TO, THE COMPLIANCE WITH APPLICABLE LAW AND REGULATIONS OF THE COUNTRY IN WHICH THE PRODUCT IS OPERATED.

Authorizations and regulations

SOME COUNTRIES MAY HAVE LAWS THAT LIMIT OR PROHIBIT THE USE OF RADIO FREQUENCY EQUIPMENT. YOU ARE SOLE RESPONSIBLE FOR SECURING ALL AUTHORIZATIONS, CERTIFICATIONS AND LICENSES REQUIRED FOR THE USE OF THE PRODUCT. FLYABILITY SA DOES NOT PROVIDE ANY LEGAL ADVICE OR COUNSELING AND UNDER NO EVENT SHALL BE LIABLE FOR ANY INFRINGEMENT OF ANY APPLICABLE LAW BY YOU.

Contents

Getting Started	12
What's In This Document.....	12
Before First Use	12
Product Description.....	13
Power Module Overview.....	15
Antenna Module Overview	16
Safety Notices	17
General Guidelines.....	17
Environmental Awareness	18
Use	19
Configuration With Standard Antennas.....	19
Configuration With Range Extender.....	20
Checklist.....	21
Trouble Shooting.....	22
Maintenance	23
Inspection.....	23
Cleaning.....	23
Component Replacement	23
Help & Support.....	23
Technical Specifications	24
General.....	24
Power Module	24
Antenna Module.....	24
Cables	25
Remote Controller	25

Getting Started

WHAT'S IN THIS DOCUMENT

This manual gets you started with setting up, packing up and maintaining your Range Extender. The following sections ensure that you use the Range Extender optimally. As soon as setup is complete, you are ready to start using the Range Extender with your Flyability aircraft.

An electronic version of this manual can be found online at <https://www.flyability.com>.

BEFORE FIRST USE

Please read the user manual carefully before first use, ensuring particular attention is paid to the Disclaimer and Safety guidelines. We also recommend that you check all tutorial videos and articles on the official Flyability website.

PRODUCT DESCRIPTION

The Range Extender is composed of 6 different elements:

1. **Configurable RC (Remote Control)** – A configurable version of Flyability's standard RC, allowing either standard antennas or the Range Extender to be used. Both configurations allow a stable connection with the aircraft built by Flyability.
2. **Removable Antennas** – The Removable Antennas can be connected directly to the Configurable RC if the Range Extender is not needed.
3. **RC Cable** – 2m in length interfacing the Configurable RC and Power Module.
4. **Power Module** – Houses the Range Extender battery and gives an audio/visual indication as to the battery's state of charge.
5. **Module Cable** – 20m in length, with marks every meter and red marks every 5m. This high quality cable interfaces the Power and the Antenna Modules.
6. **Antenna Module** – Module contains the two system antennas and signal amplification circuitry. Housing features highly reflective stickers to increase the device's visibility in low light conditions.

1. Configurable RC

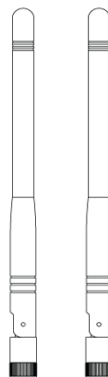
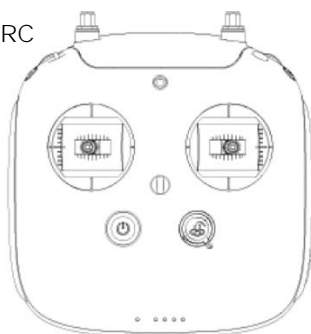

2. Removable Antennas

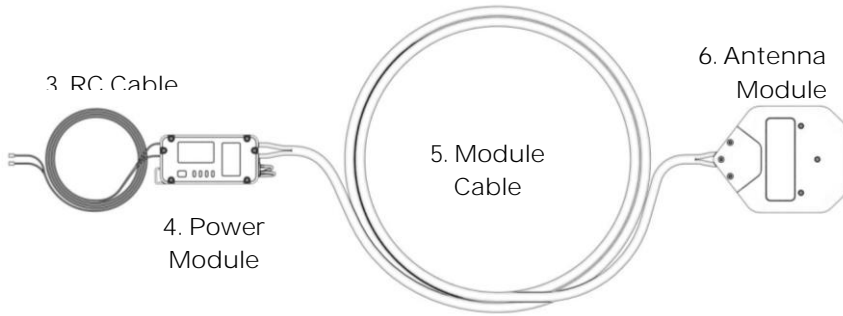

POWER MODULE OVERVIEW

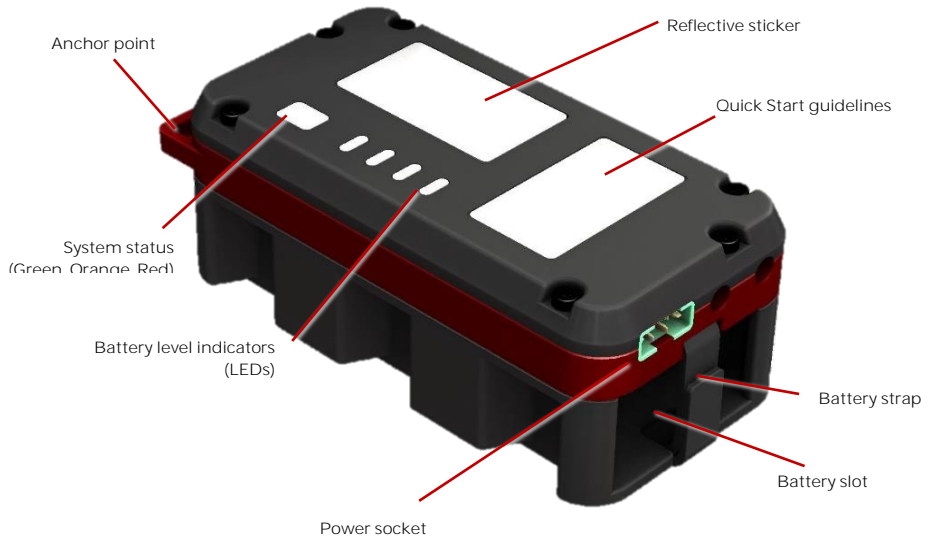

ANTENNA MODULE OVERVIEW

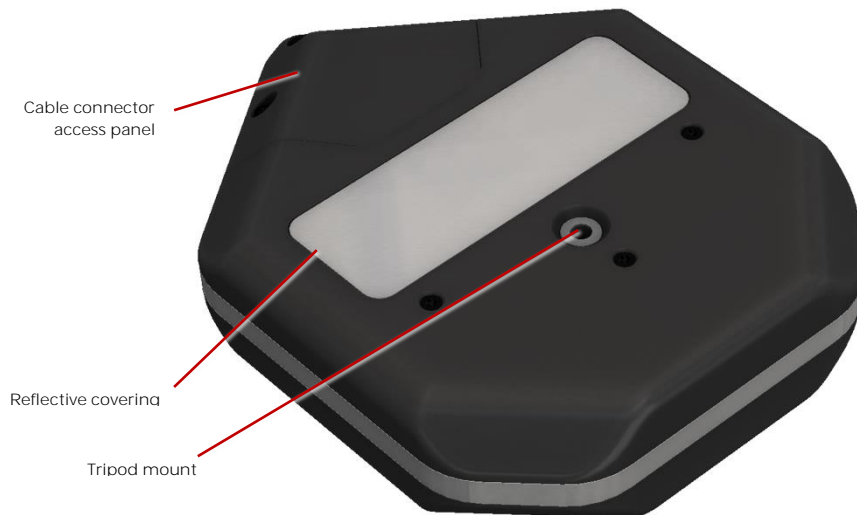

Safety Notices

GENERAL GUIDELINES

1. The operator should always act according to his or her best judgment, focusing on the safety of the people and the environment he/she is operating in.
2. Operating the Configurable RC can be stressing, tiring and can cause muscular fatigue. The Configurable RC is therefore equipped with a loop on which to attach a neck strap, use this to relieve your muscles.
3. The Power Module is equipped with an anchoring clip, this can be attached to objects in the environment to prevent the system being lost when deployed into voids.
4. DO NOT use the Range Extender under influence of alcohol, drugs or any other substances that may impair cognitive abilities.
5. A risk assessment MUST be performed before deploying the Range Extender.
6. Use only provided Flyability parts, genuine Flyability parts, or parts certified by Flyability. Using other devices or parts combination with the Range Extender (e.g. batteries, antennas, etc.) or performing unauthorized modifications may result in system malfunctioning and/or compromise safety.
7. It is recommended to use only transport cases approved by Flyability.
8. DO NOT over torque the connectors when plugging in the Removable Antennas or the RC cables.
9. ONLY use the antennas provided by Flyability or an approved reseller.
10. The Configurable RC MUST be turned on ONLY AFTER connecting the Removable Antennas or the cables. The Configurable RC MUST be turned off PRIOR TO disconnecting the Removable Antennas or the RC Cables. Not following this recommendation could severely damage the RC. Flyability is not responsible for any damages to the Configurable RC caused through improper use.
11. DO NOT use any other battery other than those supplied by Flyability. Use of other batteries may damage the product and/or affect its performance.
12. DO NOT bend the RC Cable though a radius smaller than 1cm and the Module Cable through a radius smaller than 7cm. Not respecting this can reduce the cables electrical performance and longevity.
13. After use, protective caps should be placed back on both the Configurable RC and RC Cable's connectors
14. Read carefully the Battery Safety Guidelines before using the system.

ENVIRONMENTAL AWARENESS

Always use the Range extender within the listed conditions. Doing so will reduce incidents and damage to the product.

1. The Range Extender is not waterproof. Do not use it in heavy rain/snow or in humid environments. Moisture can seriously damage the electronics of the Range Extender.
2. Store the Range Extender in a dry environment between 0°C and 30°C and protected from direct sunlight.
3. Very cold temperatures lead to reduced utilisation times. Do not use in temperatures below 0°C. Flyability cannot guarantee the Range Extender capability if not used in temperatures from 0°C to 50°C.
4. It is not recommended to use the Range Extender close to power lines, power transformers or other areas with large electromagnetic disturbances.
5. The Range Extender should not be used in or near explosive or flammable environments.
6. The removable antennas provided by Flyability, emit the highest level of radiation perpendicular to the body of the antenna. To further improve system performance, the antennas should be placed at 90° to each other.
7. The Antenna Module emits the highest level of radiation, perpendicular to the cables feeding the unit. To ensure the best performance, Flyability recommends using the system in a dry environment, with a minimum of 5cm between the antennas and surrounding surfaces. If the antenna module is in direct contact with metallic structures, the quality of the signal and range can be degraded.
8. Liquids have serious effects on the Range Extender. The Range Extender will not function correctly if in contact, half or completely submerged in water. Moreover, if the module is wet, its performance will be reduced.
9. Avoid moisture or dust entering all system connectors.

Use

Two configurations are possible:

- Configurable RC with Removeable Antennas
- Configurable RC with Range Extender

In both configurations, do not turn on the Configurable RC before completing the following setting-up procedures. Not following these guidelines can seriously damage the Configurable RC and decrease the performance of the product.

CONFIGURATION WITH STANDARD ANTENNAS

SET UP



Reminder: Turn on the Configurable RC only after connecting the antennas.

1. Remove the connector caps from the Removable Antennas and the Configurable RC
2. Screw the Removable Antennas on to the Configurable RC
3. Place the antennas at a 90° angle to each other for optimal performance

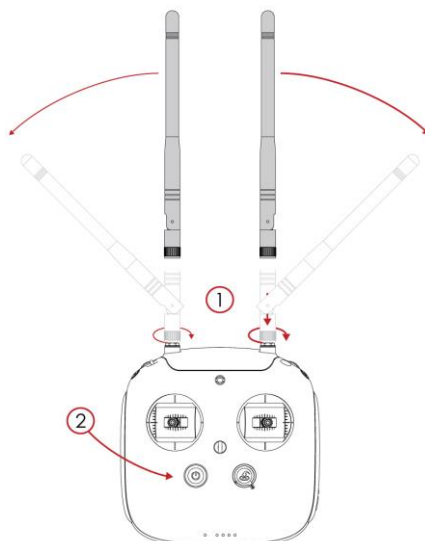

PACK UP



Reminder: Turn off the Configurable RC prior to unplugging the antennas.

1. Unscrew the Removable Antennas
2. Put the protective caps back in place on both the antennas and the Configurable RC

CONFIGURATION WITH RANGE EXTENDER

SET UP



Reminder: RC Cables MUST be connected before turning on the Configurable RC.

1. Remove the connector caps from the cables and the Configurable RC.
2. Connect the cables to the Configurable RC.
3. Attach the Power Module to the surrounding environment or to yourself with the clip and leash.
4. Deploy the Power Module Cable first avoiding any twists or knots.
5. Deploy the Antenna Module to the desired length.
6. Place and secure a battery in the Power Module.
7. Connect the battery power connector to power the system.
8. Wait for the system to initialize. If after 5 seconds the status LED is not green, please refer to the trouble shooting section.

Hint: To assist in system deployment, white marks are located along the cable every metre and red marks are located every 5 metres

PACK UP



Reminder: The Configurable RC MUST be powered down prior to unplugging the cables.

1. Disconnect the battery power connector and remove the battery from the Power Module.
2. Power down the Configurable RC.
3. Roll the Module Cable.
4. Detach the Power Module from the surrounding environment.
5. Roll the RC Cables.
6. Unscrew the RC Cables connectors from the RC.
7. Place the connector caps on the ends of the RC Cables and Configurable RC connectors.

Hint: To roll the cable to the correct diameter, align all marks placed along the cable.



CHECKLIST







Configurable RC and Removable Antennas:

- Check that the two antennas are properly mated to the Configurable RC.
- Check that the two antennas are orientated at 90° to each other.
- Check that a steady green status LED is shown on the Power Module prior to starting a mission.



Configurable RC and Range Extender:

- Check that both connectors are correctly mated to the Configurable RC.
- Check that the cables are functional. To do so, set up the Range Extender and ensure that a connection is established with the aircraft AND that it can be controlled (e.g. turning the LEDs on, tilting the camera). Then, turn off the RC and swap the cables prior to turning the RC on again. Check once again that a connection can be established with the aircraft and that it can be controlled.
- Check that all LEDs and the buzzer are functioning correctly and confirm battery level is adequate:

LED State	Signification
	LED steady
	LED blinking
	LED off

LED Pattern	Battery Level
	100% - 80%
	80% - 60%
	60% - 40%
	40% - 20%
	20% - 15%
	15% - 0%

TROUBLE SHOOTING

LED action	Sound	Signification
	Beeps (indicating the number of white LEDs illuminated) every 10 minutes.	The system is functioning correctly.
	Beeps 2 times every 1 second.	There is a connectivity issue resulting in the Antenna Module not being correctly powered. Check all system connections.

If a partially used battery is connected to the Power Module, the system is usable, however the battery state of charge estimation, as provided by the white LEDs, can be inaccurate. For this reason, Flyability recommends that a fully charged battery its used at the start of a mission.

If the 4 white LEDs are blinking, the battery state of charge is at a critical level and the system will shortly power down. After bringing the aircraft back to the operation site, change the Range Extender battery for a new one.

Maintenance

INSPECTION

From time to time perform visual checks of the following:

- Cables – Check for any cuts or abrasions.
- SMA Connectors – Check for any build-up of dirt or bent pins within the connectors.

CLEANING

To clean your Range Extender, unplug the charging cable from the Configurable RC, power down and remove the battery from the Power Module. A damp cloth slightly moistened with water or a mild detergent solution can then be used to clean the system's exterior. Avoid getting moisture into any of the openings and do not spray liquid directly on the system. Don't use aerosol sprays, abrasives or solvents such as alcohol or benzene that might damage the finish of the units.

Periodic cleaning of the SMA connectors on the Configurable RC and cables will ensure a continued high level of performance. To clean the inside of the connectors, use an appropriately sized cotton swab or tweezers and a small piece of cotton. For a more thorough clean, a small amount of denatured alcohol can be used on the swab, do not use water.

COMPONENT REPLACEMENT

The only user replaceable parts of the Range Extender are the 2m coaxial cables, the 20m coaxial cables and the RC mounted antennas, all other replacements must be performed by Flyability. Please contact Flyability for part availability and installation guidelines.

HELP & SUPPORT

Visit <https://www.flyability.com> for more information.

Technical Specifications

GENERAL

USE	Deployment/Packing time < 5 min. Can be stored in Flyability's aircraft case.
ERGONOMY	Lightweight (less than 2.5 kg). Battery change time < 1 min.
MAINTENANCE	Only Cables and Configurable RC Antennas are user replaceable, all other repairs must be carried out by Flyability.

POWER MODULE

FUNCTION	Houses the battery and provides power to the Range Extender system (NOT the Configurable RC). Displays battery state of charge and provides audible alerts. Includes integrated leash and clip for security unit to the surrounding environment.
POWER SUPPLY	Flyability 5C or 8C lithium polymer battery providing 2 hours operation time.
RUGGEDIZATION	Shock resistant (1.2 m free-fall). Temperature: 0 °C - 40 °C.

ANTENNA MODULE

FUNCTION	Transmits/Receives data to/from the aircraft.
RUGGEDIZATION LEVEL	Splash and dust resistant. Temperature: 0 °C - 40 °C.
ATTACHMENT	Thread compatible with most standard tripods (1/4-20 UNC).
VISIBILITY	Reflective surfaces visible from aircraft up to 10 meters away.
WEIGHT & DIMENSIONS	400 g (without cable). 350 mm x 150 mm x 50 mm (cannot enter aircraft cage).

CABLES

MODULE CABLE	20m cable containing dual high performance coaxial cables with a maximum pull tension of 15kg.
RC CABLE (LEFT)	2m high performance RF cable.
RC CABLE (RIGHT)	2m high performance RF cable.

REMOTE CONTROLLER

FUNCTION	Configurable controller allowing either monopole antennas or Range Extender to be connected.
VIDEO CONNECTORS	Standard HDMI output. Micro SDI output.
DATA CONNECTORS	USB type A (for tablet connection). USB micro (for updating controller firmware).
WEIGHT	810 g.
OPERATING TEMPERATURE	-10 °C to 40 °C.
BATTERY	Lithium polymer battery, 2 cells, 6000 mAh.

Content subject to change
To download latest version
Check www.flyability.com